



LaboTex

Version 3.0

The Texture Analysis Software for Windows

Determination of Volume Fraction of Texture Components Using LaboTex

Release 1.3

LaboSoft s.c.
Phone: +48 502 311838
Fax: +48 12 3953891
E-mail: office@labosoft.com.pl
@ LaboSoft 1997-2019

Notice: Pages 22 and 23 should be printed on the color printer.

CONTENTS

1. Measurement of pole figures	3
1.1 Number of pole figures	3
1.2 Grid (alpha and beta)	3
1.3 Number of counts.....	4
1.4 Correction PF for defocusing.....	4
1.5 Proper choice of PF reference system.....	7
2. ODF calculation.....	8
2.1 Preparation of pole figures to ODF calculation.	8
2.1.1 Exclude wrong quality pole figure from ODF calculation	8
2.1.2 Symmetrization.....	8
2.1.3 Rotation	11
2.1.4 Lower/upper range (bound)	12
2.2 Change of default parameters of ODF calculation	12
2.3 Crystal symmetry and cell parameter	14
3. Finding orientations	14
3.1 Isolines (colors, values, save)	14
3.2 Finding orientations on the ODF	15
3.3 Orientations (Components) Database	16
4. Evaluate width of orientation (component) peak	18
5. Volume fraction calculation	21

1. Measurement of pole figures

Preliminary stage in determination of volume fraction is measurement of pole figures. This stage is very important if we want to get good results.

1.1 Number of pole figures

- LaboTex break ODF calculation when the quantity of the information from pole figure is too small;

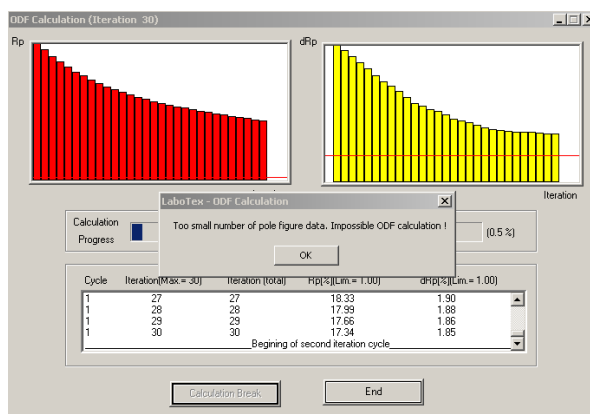

- more pole figures with good quality - better results;
- user may exclude wrong quality pole figure from ODF calculation (see to point 2a);
- user may exclude wrong quality fragment of pole figure from ODF calculation (see to point 2a).

1.2 Grid (alpha and beta)

Step of alpha and beta angles (grid) should be less than the half-width at half-height of the texture component peak. On the LaboSoft WWW pages are examples for download which show both convergence of ODF calculation and accurate of ODF calculation in dependence on width of texture component and step of alpha and beta angles (400_011.zip). Examples are for {400}<011> model component:

Model comp. FWHM /deg/	grid /deg/	file	symme- trization	ODF cal- lat. converg.	Volume fraction calculation		
					component	ranges*	%
10	5	400_011_10_5.ppf	orthorh.	Yes	{400}<011>	15	99.74
10	1	400_011_10_1.ppf	orthorh.	Yes	{400}<011>	15	100.32
5	5	400_011_5_5.ppf	orthorh.	Weak	{400}<011>	10	99,89
5	1	400_011_5_1.ppf	orthorh.	Yes	{400}<011>	7.5	99,86
2	5	400_011_2_5.ppf	orthorh.	No	{400}<011>	10	36,29
2	2	400_011_2_2.ppf	orthorh.	No	{400}<011>	6	26,54
2	1	400_011_2_1.ppf	orthorh.	Yes	{400}<011>	3	99.86

*delta phi1=delta phi = delta phi2 (in deg)

Warning: Before start volume fraction calculation for grid lower than 2.5*2.5 please press button "Show high resolution ODF" (button with icon "R"). Calculation please doing for "Singly Counts in Overlapping Area" method (default method).

Comments to results:

Examples for 10 and 5 degree width of the texture component and grid equal 5 and 1 deg give the results about 100%.

Example 400_011_2_5.ppf and 400_011_2_2.ppf **are divergent** hence calculated volume fraction is incorrect.

Example 400_011_2_1.ppf have a **very good convergence** and result about 100%. In this case angle steps are less than the half-width at half-height of the texture component peak.

Notice: small step make ODF calculation essentially longer! Use optimal grid for your problem.

1.3 Number of counts

Number of counts should be enough - not too little. 400_011.zip file contains 2 examples: Si-EK-filtr.ppf and Si-EK-filtr1.ppf. Both files are converted from sample with sharp texture and values '0' and '1' on the large area of PF in the following way:

1. Si-EK-filtr.ppf - in which all values '0' or '1' set to '0'
2. Si-EK-filtr1.ppf - in which all values '0' or '1' set to '1'

Convergence for sample Si-EK-filtr1.ppf is very good when for sample Si-EK-filtr.ppf is divergent. Hence Si-EK-filtr.ppf has broadened {400}<011> component peak!!!. Difference between calculated volume fraction of {400}<011> component among Si-EK.ppf and Si-EK-filtr1.ppf is about 30% for 5 deg integration ranges. Similar error may be connected with improper data format or with bad correction of PF for defocusing.

WARNIG: Data format may also make worse quality of data - some data formats (for example: popLA/old-BearTex EPF format) have only 3 significant digits in range from 0 to 999 - if it is possible you should avoid such data format especially for sharp texture.

For example: below is fragment of file which shows:

- too low number of counts,
- lost information by improper conversion to format with only 3 significant digits (mainly from background - only '0' or '1'),
- too big a grid:

```
...
  1  1  1  1  1  1  1  1  1  1  1  1  1  1  1  1  1  1  1  1
  1  1  1  1  1  1  1  1  1  1  1  1  1  1  1  1  1  1  1  1
  1  1  1  1  1  1  1  1  1  1  1  1  1  1  1  1  1  1  1  1
286  1  1  1  1  1  1  1  1  1  1  1  1  1  1  1  1  1  1  1
  1  1  1  1  1  1  1  1  1  1  1  1  1  1  1  1  1  1  1  1
  1  1  1  1  1  1  1  1  1  1  1  1  1  1  1  1  1  1  1  1
  1  1  1  1  1  1  1  1  1  1  1  1  1  1  1  1  1  1  1  1
  1  1  1  1  1  1  1  1  1  1  1  1  1  1  1  1  1  1  1  1
  1  1  1  1  1  1  1  1  1  1  1  1  1  1  1  1  1  1  1  1
  1  1  1  1  1  1  1  1  1  1  1  1  1  1  1  1  1  1  1  1
  1  1  1  1  1  1  1  1  1  1  1  1  1  1  1  1  1  1  1  1
  1  1  1  1  1  1  1  1  1  1  1  1  1  1  1  1  1  1  1  1
  0  0  0  0  0  0  0  0  0  0  0  0  0  0  0  0  0  0  0  0
  0  0  0  0  0  0  0  0  0  0  0  0  0  0  0  0  0  0  0  0
  0  0  0  0  0  0  0  0  0  0  0  0  0  0  0  0  0  0  0  0
  0  0  0  0  0  0  0  0  0  0  0  0  0  0  0  0  0  0  0  0
...

```

1.4 Correction PF for defocusing

LaboTex offers the choice of one from three methods of defocusing correction:

- from powder /random/ pole figures;
- from correction files;
- from Shultz formula.

(for details see to LaboTex help and also to point 1.3)

Good defocusing correction is extremely important for ODF calculation.

Below is example for Zirconium sample. This sample was corrected by Schulz formula (see New Sample --> Correction Data from Formula) for different correction parameter $\mu*\tau$ (where μ – absorption coefficient, τ – penetration depth). Results of calculation are presented in table and on the figure. Fit error of ODF calculation was strong dependent on the correction parameter. ODF calculation was even divergent for large $\mu*\tau$ values (overcorrection). RP attains the minimum for $\mu*\tau$ equal about 0.425.

Correction parameter $\mu*\tau$ (μ –absorption coefficient, τ –penetration depth)	ODF calculation convergence	RP (fit error)
1.0	NO	135.8
0.9	NO	98.1
0.8	NO	72.0
0.7	YES	53.2
0.6	YES	36.6
0.5	YES	26.1
0.45	YES	23.5
0.425	YES	23.1
0.4	YES	23.7
0.3	YES	28.5
0.2	YES	34.2
0.1	YES	40.7
0.01	YES	49.1
No correction	YES	50.2

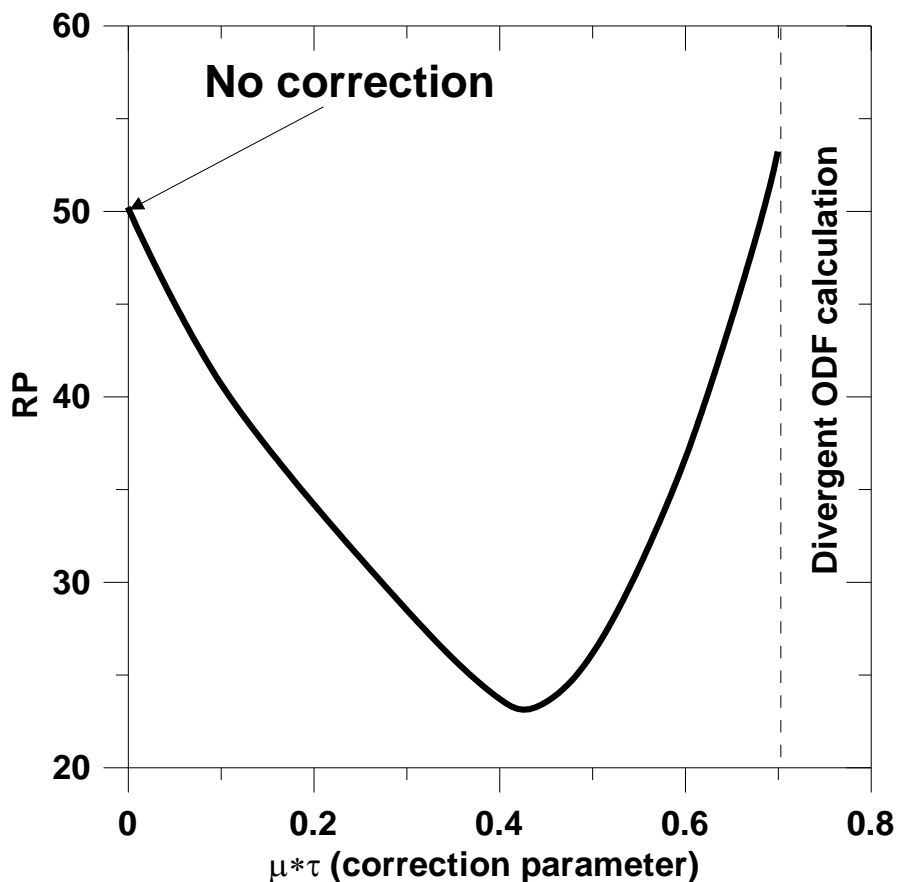

Below is comparison of corrected pole figures (CPF) for Zr sample and pole figures recalculated from ODF (RPF) when correction was 'off' during creation of CPF (no defocusing correction). CPFs and RPFs are different for all pole figures.

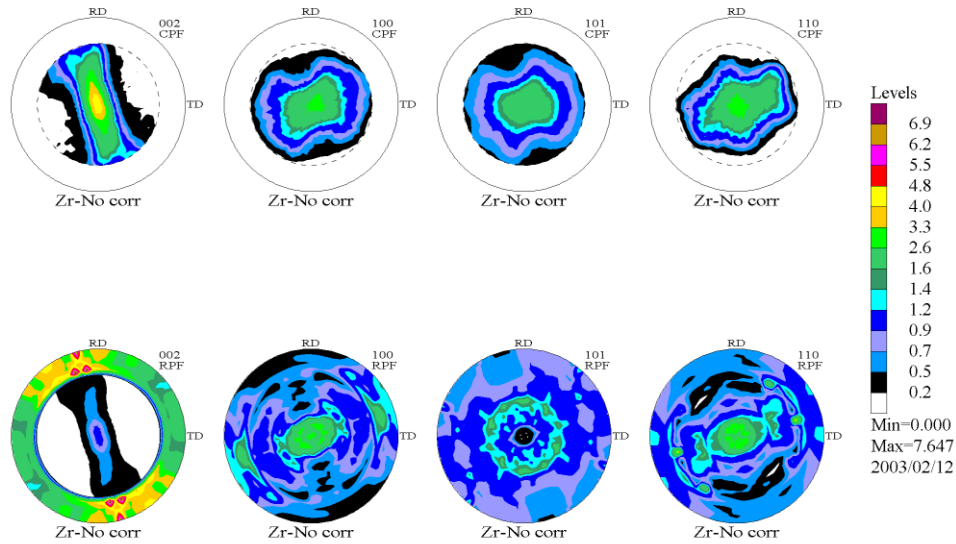

Below is comparison of corrected pole figures (CPF) for Zr sample and pole figures recalculated from ODF (RPF) when correction parameter $\mu*\tau$ was equal 1.0. CPFs and RPFs are also different for {100}, {101} and {110} pole figures.

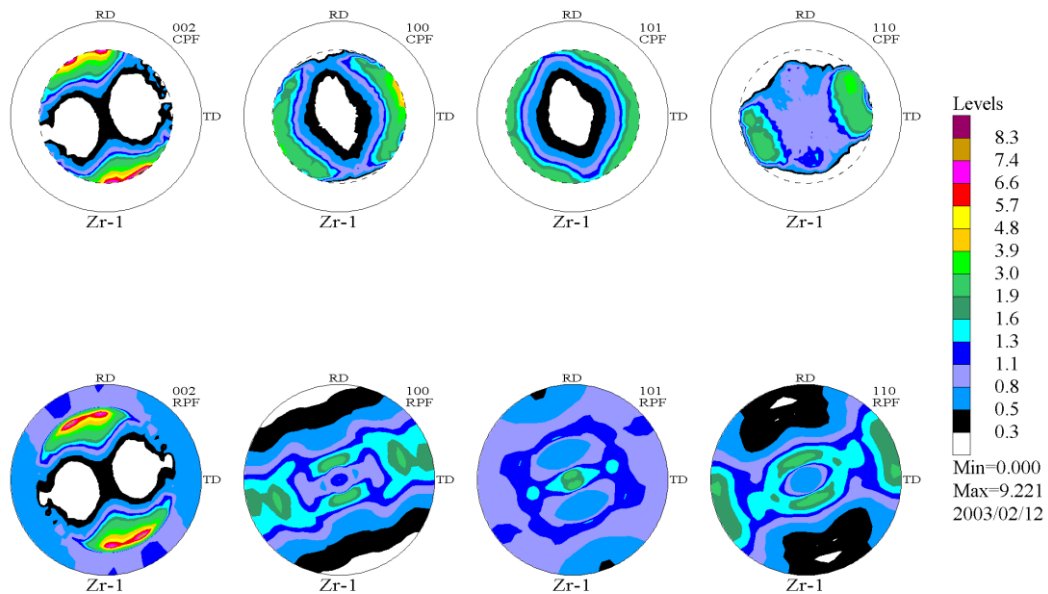

Below is comparison of corrected pole figures (CPF) for Zr sample and pole figures recalculated from ODF (RPF) when correction parameter $\mu*\tau$ was equal 0.425 (minimum RP value). In this case CPFs and RPFs are similar in measure range for all pole figures .

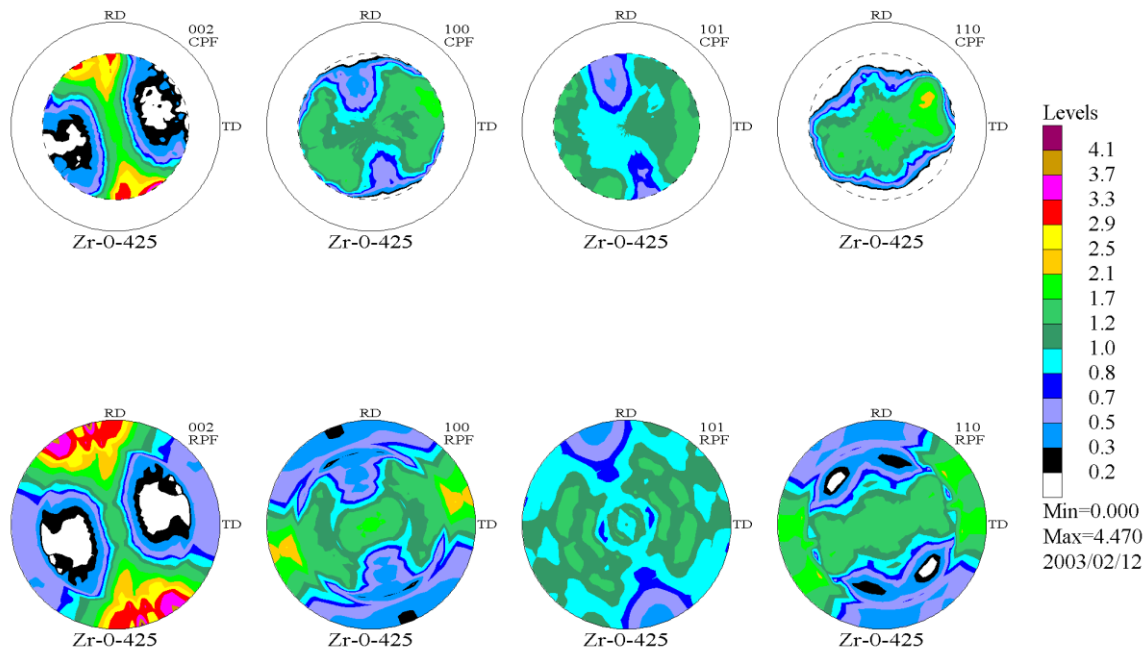

Improper defocusing correction conducts to different ODF and to error in determination of volume fraction of texture components. Correction of pole figures for defocusing using Schulz formula is approximate only. The best correction is for good prepared powder sample with the same material as measured sample.

1.5 Proper choice of PF reference system.

If there is a rotation/mirror between the PF plotted using another texture software (for example from your XRD) and from LaboTex then there are three questions concerning this problem:

A) Different ways of pole figures plotting (check it in your XRD software description):

a) rotation and direction

- (1) clockwise rotation from the NS direction
- (2) counterclockwise rotation from the NS direction
- (3) clockwise rotation from the WE direction
- (4) counterclockwise rotation from the WE direction

LaboTex uses the pole figures presentation as in point A.1.

b) projection

- (1) stereographic projection
- (2) equal area projection

LaboTex uses the standard stereographic projection.

If ODF from LaboTex and ODF from your XRD software (or other software) are similar then difference is only in pole figure presentation (different pole figures plotting convention). If ODF from LaboTex and ODF from your other texture software are different then pole figures measurements convention can be different (B) or there is error in input of data (C).

B) Different ways of registration of pole figures in the dependence from the motion of the texture goniometer are (check it in your XRD description):

- (1) clockwise rotation from the RD direction
 - (2) counterclockwise rotation from the RD direction
 - (3) clockwise rotation from the TD direction
 - (4) counterclockwise rotation from the TD direction
- LaboTex uses most popular convention B.1.

Warning: You can find more about plot and registration convention in "Pole Figures: Plot and Registration Conventions" (<http://labotex.com> ----> download).

C) LaboTex read improper your data format or your data contain error.

2. ODF calculation

2.1 Preparation of pole figures to ODF calculation.

LaboTex has several ways for preparation of pole figures to ODF calculation: exclude wrong quality pole figure(s) from ODF calculation, symmetrization, rotation, exclude wrong quality areas of pole figure(s) from ODF calculation (lower/upper range - bound).

2.1.1 Exclude wrong quality pole figure from ODF calculation



For example: above image show case when user exclude {110} pole figure from ODF calculation. Default LaboTex include all pole figures to ODF calculation (all button are pressed when you chose ODF calculation option)

2.1.2 Symmetrization

Symmetrization (choose of sample symmetry) - you should choose highest possibly sample symmetry. LaboTex shows you available for your sample kinds of symmetrization (remaining are grey):

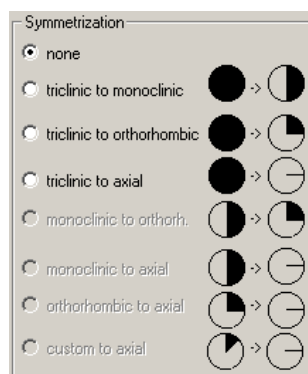

Example 1 : O_Cubic sample - Below are images of pole figures $\{100\}$, $\{111\}$, $\{221\}$ and $\{113\}$ for symmetrization 'triclinic to monoclinic' :

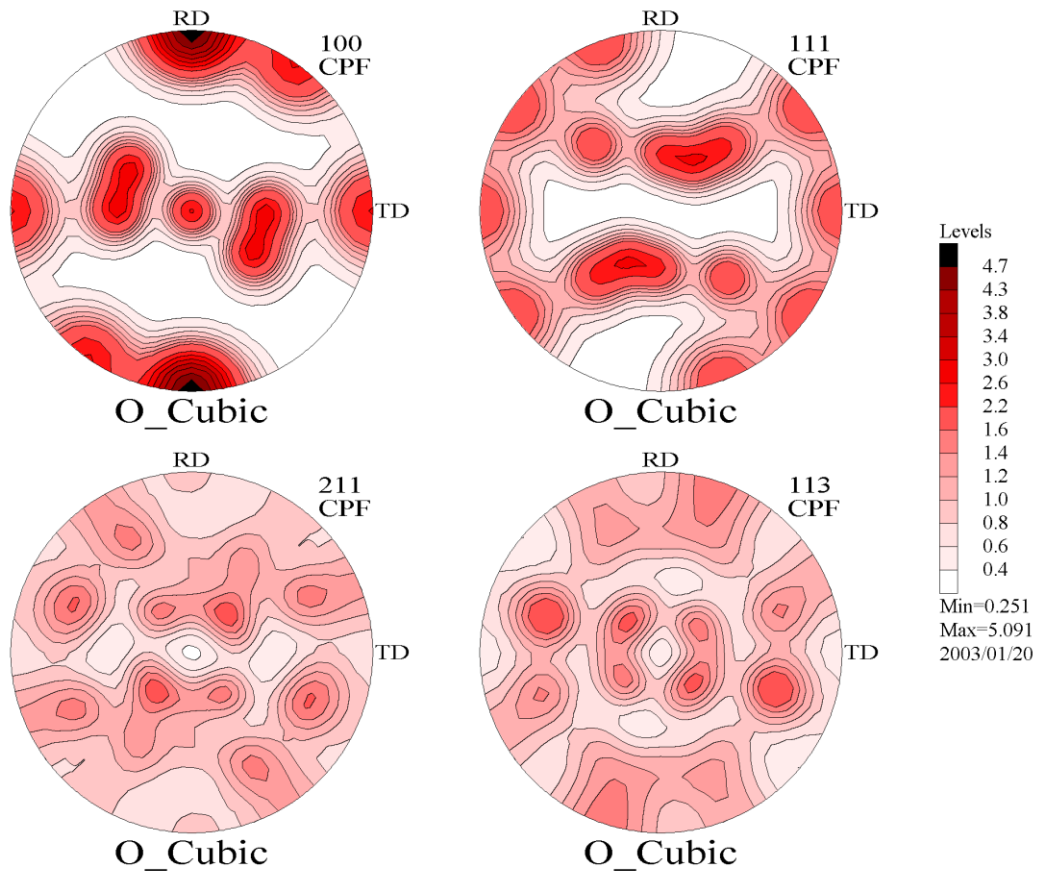

and for symmetrization 'triclinic to orthorhombic' :

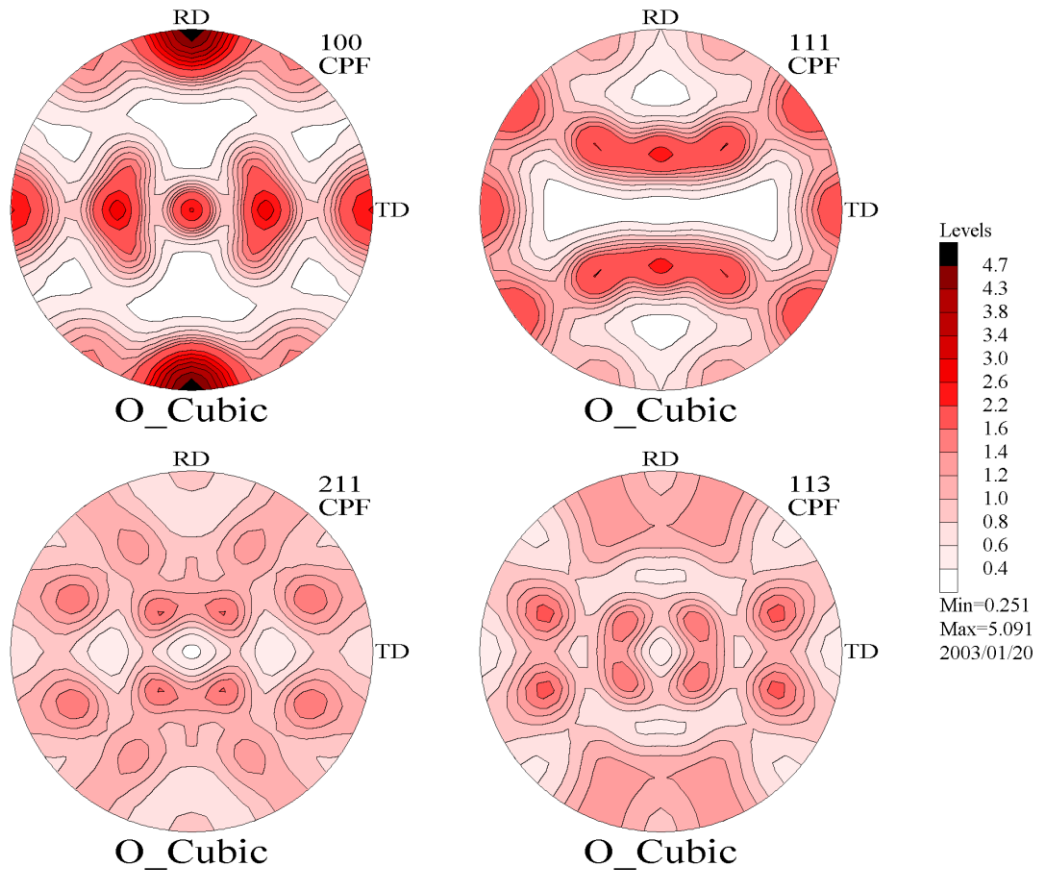

Only symmetrization from "Triclinic to monoclinic" don't change appearance of pole figures.

Example 2: Below are images of pole figures $\{111\}$, $\{200\}$ and $\{220\}$ for symmetrization 'none' for sample 111-POL:

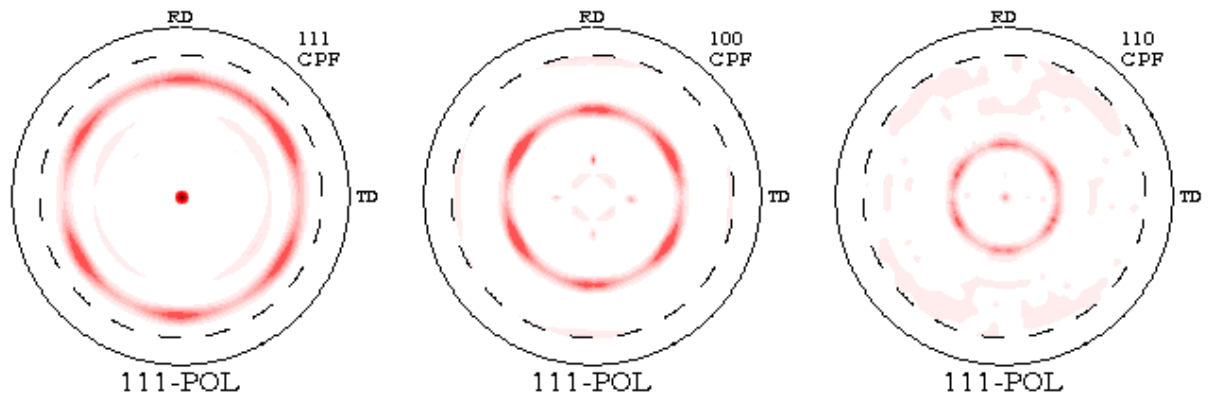

When you choose symmetrization from "Triclinic to monoclinic" you can see that images of pole figures almost don't change appearance:

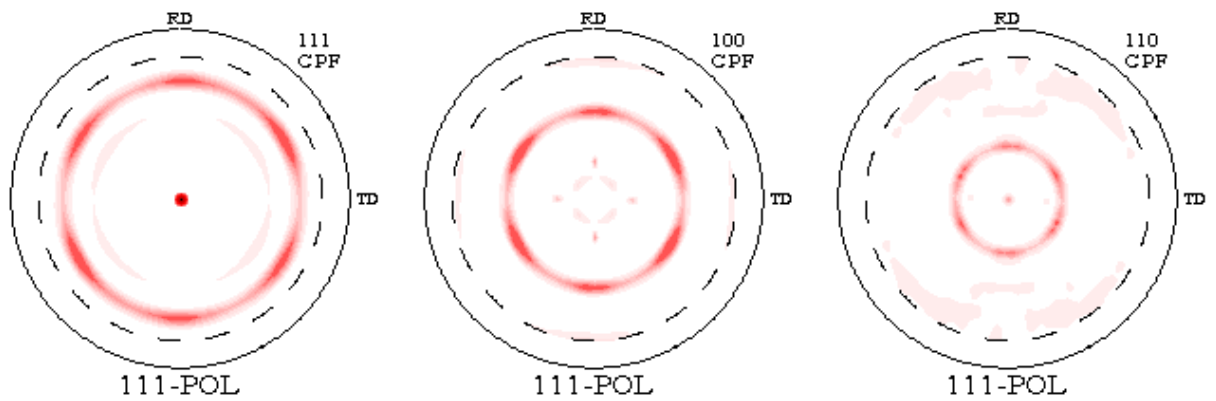

Next you may try choose symmetrization from "Triclinic to orthorhombic". Pole figures also don't change appearance in this case because they have orthorhombic sample symmetry.

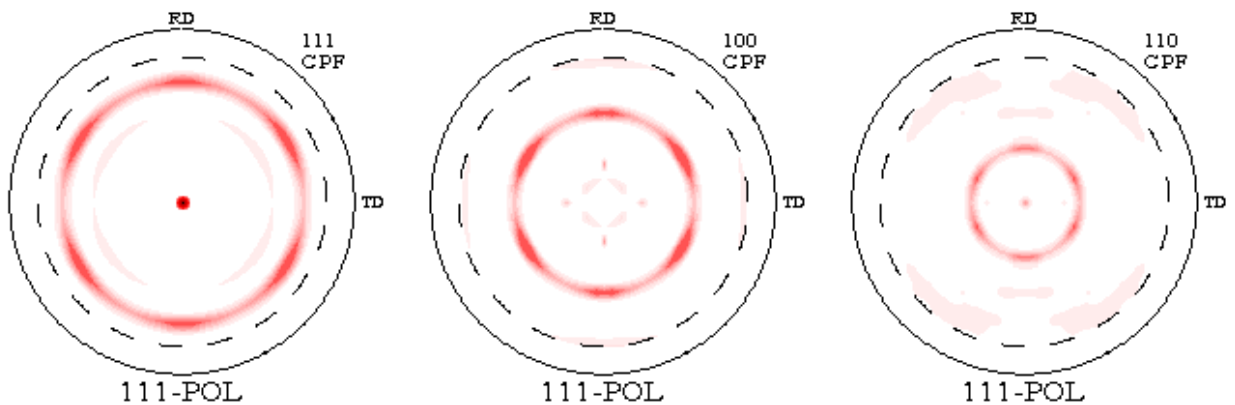

If you choose symmetrization from "Triclinic to axial" you can see change in appearance of pole figures.

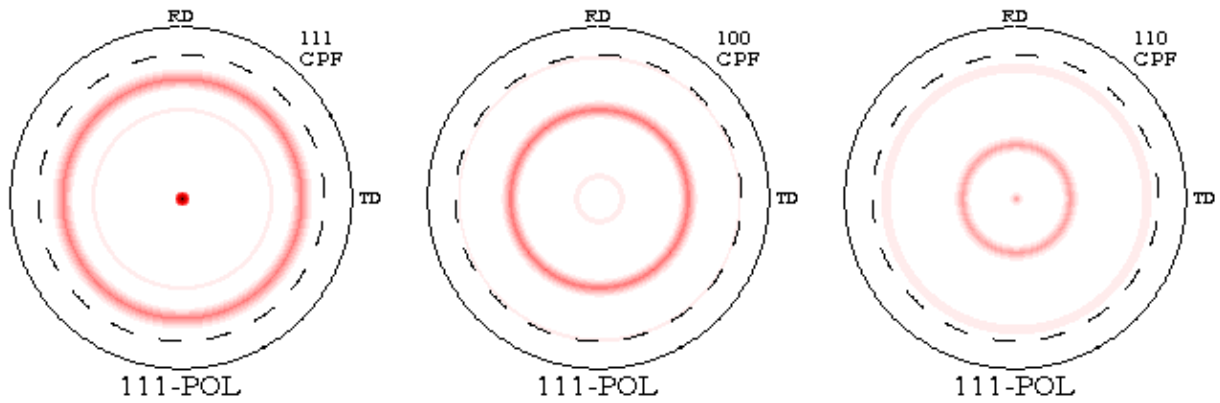

Recapitulating: For ODF calculation and analysis you should in case of example 2 make "Triclinic to orthorhombic" symmetrization (orthorhombic sample symmetry), but because 111-POL sample is close to axial symmetry you may also make approximation analysis for axial symmetry but with lost some informations. Sample O-Cubic (with demo project) contains pole figures with monoclinic sample symmetry. Already symmetrization "Triclinic to orthorhombic" clearly changes appearance of pole figures in this case.

Warning: Before symmetrization you should set proper values, colors and number of isolines !
Fill option may also help. 14 isolines is often necessary.

2.1.3 Rotation

You may select rotation angle of PF(s) by change slider position (it is not necessary for analyzed sample POL-111). This option may be important in case 1.e.B.

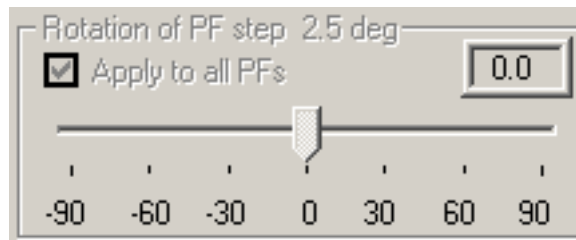

Warning: You can change rotation angle before symmetrization change only.

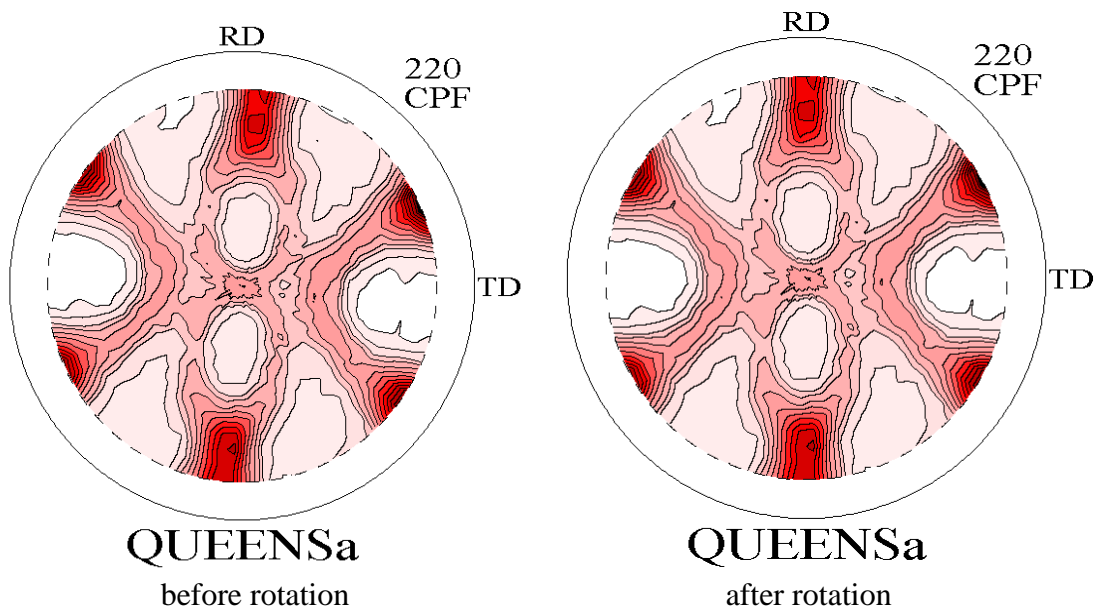

2.1.4 Lower/upper range (bound)

Data near $\alpha=90$ degrees are inaccurate for reflection technique whereas for transmission technique inaccurate are data for $\alpha=0$. LaboTex user can change lower/upper range and exclude inaccurate data from ODF calculation. If you have problem with convergence of calculation you can try this way.

For example: In below example user include to ODF calculation range from 0 to 75 deg for all pole figures (pole figures were measure to 80 deg)

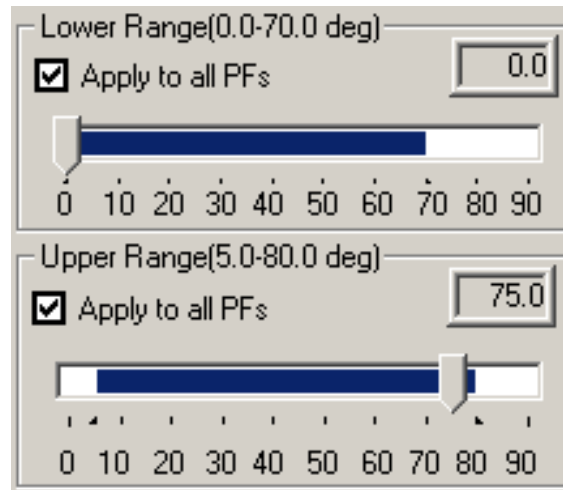

'111-pol' pole figures are in range 0-80 degrees and clipping of pole figures is unnecessary.

2.2 Change of default parameters of ODF calculation

Default parameters of calculation of ODF in LaboTex are sufficient in most case of calculation (30 iterations, 1% RP and 1% dRP) :

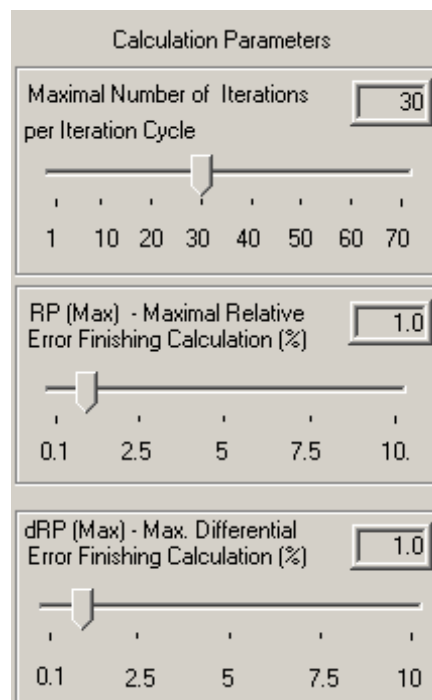

If LaboTex finish calculation by maximal number of iterations you can try increase this number. You can investigate process of ODF calculation and convergence after completion of calculation. Click on

the ODF image right mouse button or click on the report button on the information window (Info ODF). LaboTex display ODF Calculation Report.

Warning: In Analysis Mode right mouse button click shows near orientations instead ODF Calculation Report.

The ODF Calculation Report shows also texture index - 'f2' parameter, which inform about sharpness of texture (it is grater for sharpness texture).

Example of ODF Calculation Report:

it - iteration number

f2 - texture index

RP - global Rp

{hkl} - Rp for figure {hkl}

```
-----
Symmetrization :triclinic to axial
Rotation of PF(s) (Deg.)= 0.0
Lower Range of PF(s) (Deg.)= 0.0
Upper Range of PF(s) (Deg.)= 80.0
Pole figure data converted with GADDS-WNT V4
```

it	f2	RP	{111}	{100}	{110}
1	0.9	222.4	402.4	207.8	56.9
2	1.8	202.8	391.8	166.6	49.9
3	5.0	174.3	354.8	126.9	41.2
4	11.4	143.7	303.3	94.5	33.4
5	19.8	117.6	254.4	71.6	26.7
6	27.8	99.6	218.0	56.0	24.7
7	34.1	87.7	191.8	47.1	24.1
8	38.7	80.0	173.5	42.2	24.5
9	41.8	74.9	160.8	39.3	24.8
10	43.9	71.7	152.5	37.4	25.1
11	45.3	69.6	146.8	36.3	25.7
12	46.4	68.2	142.7	35.5	26.3
13	47.1	67.1	139.8	34.9	26.7
14	47.7	66.4	137.5	34.7	27.1
15	48.1	65.9	135.6	34.6	27.3

```
----- second iteration cycle -----
```

16	0.4	201.6	359.6	190.3	55.0
17	4.7	167.9	295.4	155.1	53.4
18	10.0	138.9	253.8	115.7	47.3
19	14.7	120.9	227.6	93.8	41.3
20	17.9	110.4	211.2	82.0	38.1
21	20.0	104.3	200.6	75.7	36.4
22	21.4	100.3	193.6	71.8	35.6
23	22.4	97.5	188.6	69.0	35.0
24	23.2	95.5	184.7	66.9	34.7
25	23.8	93.9	181.7	65.4	34.5
26	24.2	92.6	179.4	64.2	34.4
27	24.6	91.6	177.5	63.2	34.3
28	24.9	90.8	176.0	62.3	34.2

```
----- third iteration cycle -----
```

29	61.1	61.6	102.8	42.4	39.6
30	57.0	62.2	106.7	41.9	37.9

```
-----
```

2.3 Crystal symmetry and cell parameter

You should choose proper crystal symmetry and proper cell parameter. ODF for lower than cubic symmetry is relative to choice of cell parameters. In LaboTex we use of most popular Matthies convention. LaboTex does not permit input parameters of cell in other order.

For example:

In case of pole figures: {020},{110},{200},{201},{310} for sample with orthorhombic crystal symmetry, cell parameters $a=0.741\text{nm}$; $b=0.495\text{nm}$, and $c=0.255\text{nm}$ are in incorrect order. In accordance with Matthies convention it should be in order : $a=0.255\text{nm}$ $b=0.495\text{nm}$ $c=0.741\text{nm}$ or in relative units: $a=1$. $b=1.94$ $c=2.91$ (angles are the same: 90,90,90), hence pole figures hkl should be input as below in second column:

```
020 ---> 020
110 ---> 011
200 ---> 002
201 ---> 102
310 ---> 013
```

3. Finding orientations

3.1 Isolines (colors, values, save)

After calculation of ODF we should find significant texture components.

For example: ODF of sample 111-POL calculated with axial symmetry has very sharp $\langle 111 \rangle$ component and other components are invisible at standard sets of isolines (automatic) even for 14 isolines (figure a).

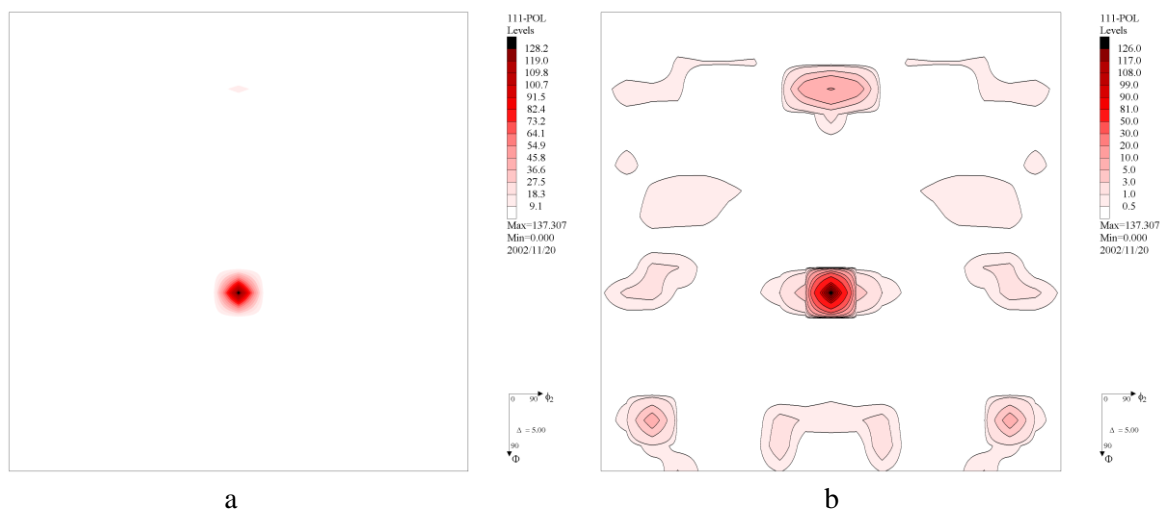

In the first step we should choose set of isolines color and changes isolines values :

Isoline No	1	2	3	4	5	6	7	8	9	10	11	12	13	14
Values	0.5	1.0	3.0	5.0	10.0	20.0	30.0	50.0	80.0	90.0	99.0	108.0	117.0	126.0

On the figure b we can see more orientations than only $\langle 111 \rangle$ fiber.

Notice: to change values of isolines please:

- choose "MANUAL" in "ODF isolines mode/ Load ODF isolines" on the information window (Info ODF) (change from "AUTOMATIC" to "MANUAL")

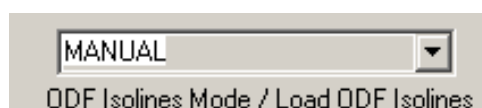

- edit all isolines values which you want in "isolines/values" windows

Isolines/Levels for ODF

Color	No	Value	Color	No	Value
	1	0.5		8	50.0
	2	1.0		9	81.0
	3	3.0		10	90.0
	4	5.0		11	99.0
	5	10.0		12	108.0
	6	20.0		13	117.0
	7	30.0		14	126.0

Dec. Digit: 1, None, All, Sort

- mark box "Value" (or/and "Color", "State")

ODF Isolines Mode / Load ODF Isolines

Color Value State

Save ODF Isolines

- press the "Save ODF Isolines" and save the isolines to the file (for example: "POLE")
- any time you want, you can load this isolines from the file (change from "AUTOMATIC" to "POLE")

POLE

ODF Isolines Mode / Load ODF Isolines

Now you can see not only $\langle 111 \rangle$ compounds.

3.2 Finding orientations on the ODF

Press ODF analysis :



On the window you can see $\langle 111 \rangle$ fiber orientation with great ODF value.

Next click right mouse button in the place about maximal ODF values in some area other then $\langle 111 \rangle$ fiber.

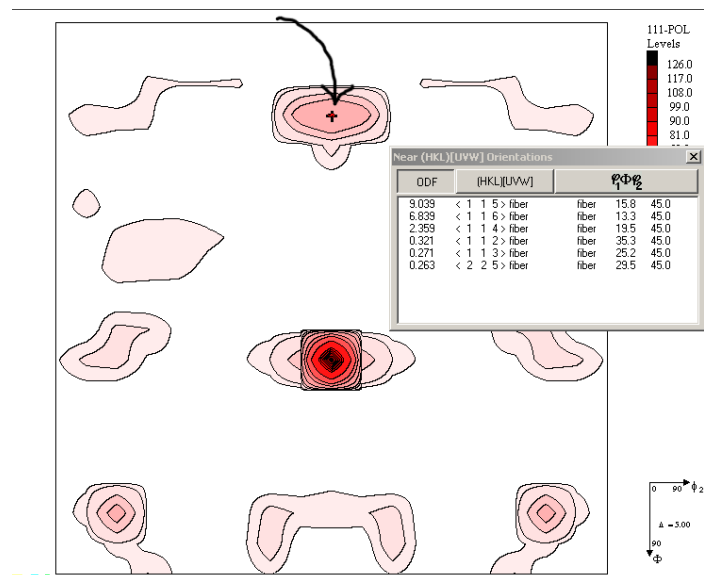

3.3 Orientations (Components) Database

Add orientation which you have found to the database (2 steps):

1) Click on the HKL (1^o step)

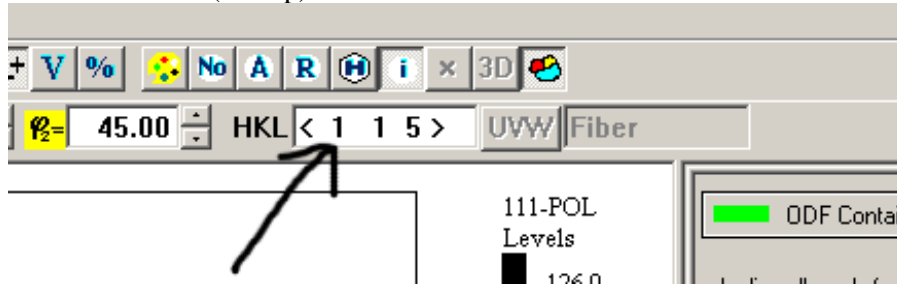

2) Click on the "Add to Database" (2^o step)

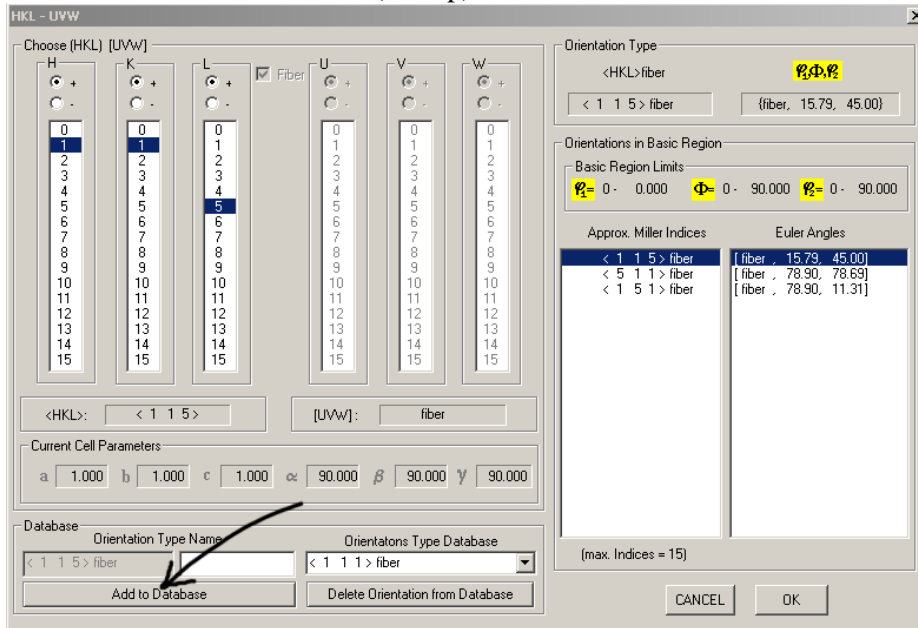

You can find on the right side of HKL UVW window other orientations which are symmetrically equivalent for $\langle 115 \rangle$ fiber orientation: $\langle 511 \rangle$ fiber and $\langle 151 \rangle$ fiber. All these orientations belong to one texture components. Registration only one orientation from component in the database is sufficient. Click on $\langle 511 \rangle$ fiber position on the list "Approx. Miller Indices" and next click "OK" button. Now you can see this orientation on the ODF:

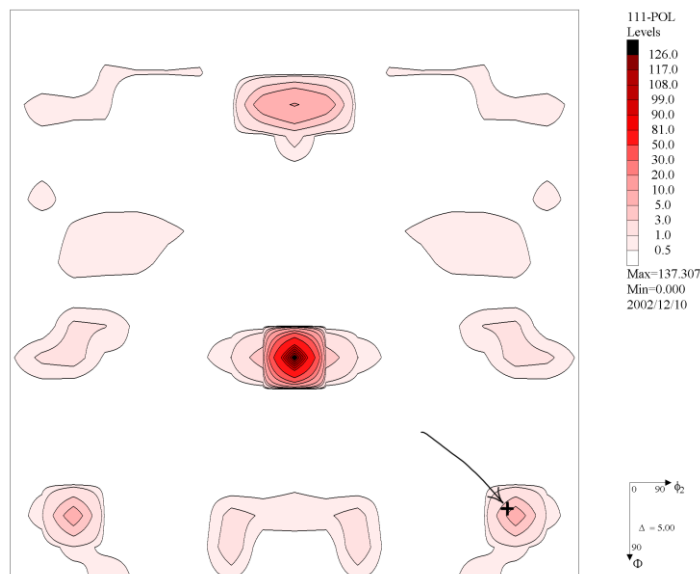

You can also check position of $\langle 151 \rangle$ fiber orientation.

Next start seek in the same way of other orientations.
 Finish when you find all essential texture orientations:

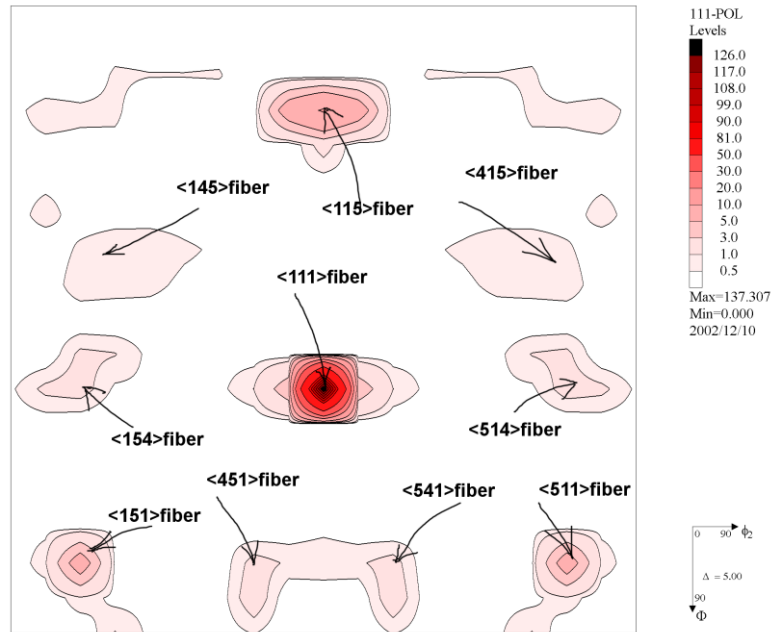

These orientations belong to three texture components (symmetrically equivalent orientations):

- 1) $\langle 111 \rangle$ fiber
- 2) $\langle 115 \rangle$ fiber ($\langle 115 \rangle$ fiber, $\langle 151 \rangle$ fiber, $\langle 511 \rangle$ fiber)
- 3) $\langle 145 \rangle$ fiber ($\langle 145 \rangle$ fiber, $\langle 415 \rangle$ fiber, $\langle 154 \rangle$ fiber, $\langle 514 \rangle$ fiber, $\langle 451 \rangle$ fiber, $\langle 541 \rangle$ fiber)

Remaining components are too weak to the analysis.

Notice: If you analyzing more samples and you would like to compare these samples then components and integration ranges for all samples should be the same.

4. Evaluate width of orientation (component) peak

Press "**Quantitative analysis**" button and chose orientation which you have found in previous step:

No	Orientation Type	On
1	< 1 1 1 > fiber	<input checked="" type="checkbox"/>
2	< 1 1 5 > fiber	<input checked="" type="checkbox"/>
3	< 1 4 5 > fiber	<input checked="" type="checkbox"/>
4	{ fiber , 78.90, 11.31} CURSOR !!!	<input type="checkbox"/>
5	< 5 7 1 > fiber	<input type="checkbox"/>
6	< 4 1 15 > fiber	<input type="checkbox"/>
7	< 4 1 15 > fiber	<input type="checkbox"/>
8	< 1 5 4 > fiber	<input type="checkbox"/>
9	< 1 4 5 > fiber	<input type="checkbox"/>
10	< 1 5 4 > fiber	<input type="checkbox"/>

Next you should evaluate width of peak for this orientation and input integrations ranges.

Integrations ranges should:

- include entire peak
- don't overlap with other orientations and with symmetrically equivalents (if it is possible)
- if you analyzed series of samples then evaluate integration ranges for sample with the widest peak in given direction

Next chose component number:

$\Delta\theta_1 =$ fiber

No	Orientation Type	On
1	< 1 1 1 > fiber	<input checked="" type="checkbox"/>
2	< 1 1 5 > fiber	<input checked="" type="checkbox"/>

or click on component (or any sym. equivalent) on the list:

[φ_1 , Φ , φ_2]

< 1 1 1 > fiber
[fiber, 54.74, 45.00]
< 1 1 5 > fiber
[fiber, 15.79, 45.00]
[fiber, 78.90, 78.69] (Sym.Eq.)
[fiber, 78.90, 11.31] (Sym.Eq.)
< 1 4 5 > fiber
[fiber, 39.51, 14.04]
[fiber, 51.89, 78.69] (Sym.Eq.)
[fiber, 81.12, 38.66] (Sym.Eq.)
[fiber, 39.51, 75.96] (Sym.Eq.)
[fiber, 51.89, 11.31] (Sym.Eq.)
[fiber, 81.12, 51.34] (Sym.Eq.)

For axial sample symmetry you should only input integration ranges: delta Phi and delta phi2. Use slider from right side of 3 diagram to precisely display bottom of peak. Next you can simply find proper integrations ranges of peaks.

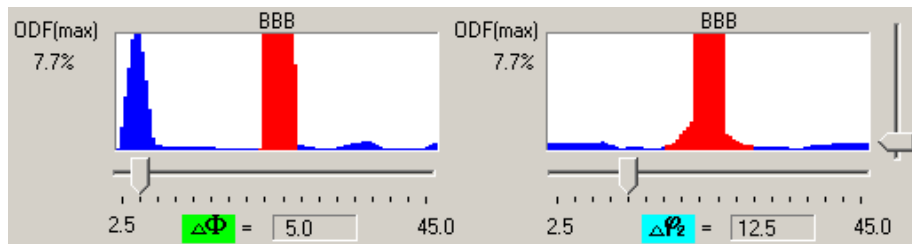

You can view cross section not only from central point of integration, but also from many other:

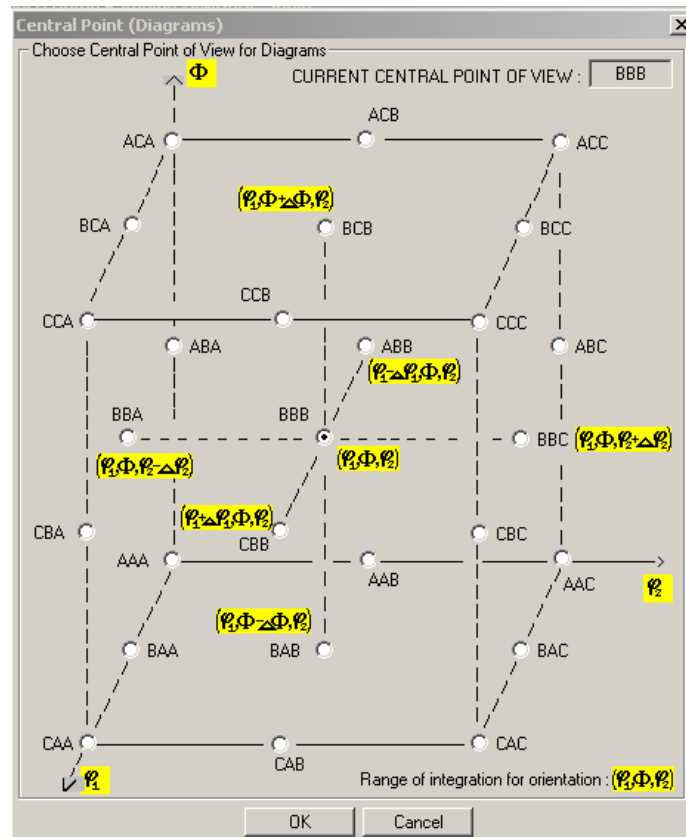

Delta Phi1, Delta Phi and Delta Phi2 mean the half width of the integration range around chosen orientation (**and all symmetrically eq.!!!**). So, if orientation is PHI1, PHI, PHI2, then the volume fraction is integrating in the range:

- [PHI1 - DeltaPhi1 , PHI1 + DeltaPhi1]
- [PHI - DeltaPhi , PHI + DeltaPhi]
- [PHI2 - DeltaPhi2 , PHI2 + DeltaPhi2]

for all symmetrically equivalent positions (orientations) of component.

Of course you can chose different Delta for each Euler angle and for each selected orientation (using view of the orientation profiles in each Euler angle cross section).

For fiber orientations calculation are made in entire Phi1 range (you can't choose delta Phi1 in this case).

No	Orientation Type	On	$\Delta\varphi_1$	$\Delta\Phi$	$\Delta\varphi_2$
1	< 1 1 1 > fiber	<input checked="" type="checkbox"/>	fiber	5.0	12.5
2	< 1 1 5 > fiber	<input checked="" type="checkbox"/>	fiber	5.0	10.0
3	< 1 4 5 > fiber	<input checked="" type="checkbox"/>	fiber	7.5	12.5
4	{ fiber , 78.90, 11.31} CURSOR !!!	<input type="checkbox"/>	fiber	10.0	10.0
5	< 5 7 1 > fiber	<input type="checkbox"/>	fiber	10.0	10.0
6	< 4 1 15 > fiber	<input type="checkbox"/>	fiber	10.0	10.0
7	< 4 1 15 > fiber	<input type="checkbox"/>	fiber	10.0	10.0
8	< 1 5 4 > fiber	<input type="checkbox"/>	fiber	10.0	10.0
9	< 1 4 5 > fiber	<input type="checkbox"/>	fiber	10.0	10.0
10	< 1 5 4 > fiber	<input type="checkbox"/>	fiber	10.0	10.0

For example: Component <111>fiber has only one sym. eq. and integration range is in entire Φ_1 range (fiber orientation), $54.74 - \Delta\Phi_1$ to $54.74 + \Delta\Phi_1$ for Φ_1 and $45 - \Delta\Phi_2$ to $45 + \Delta\Phi_2$ for Φ_2 Euler angle. Component <151>fiber has three symmetrically equivalent positions and integration range is sum integration ranges around these three orientations.

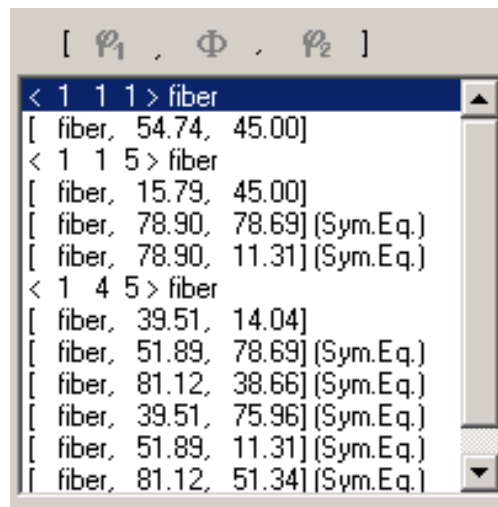

When you have finished you may save components and their integration ranges. Click button "Save Current Set" and input name of set.

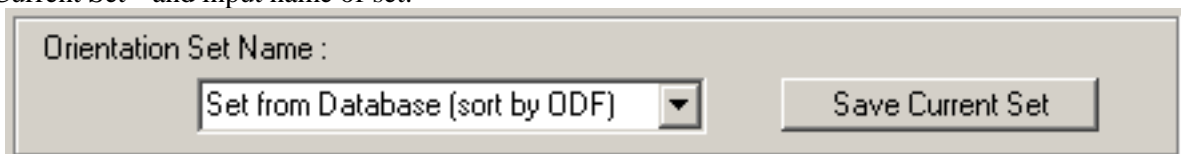

You may also evaluate FWHM (the full width of the texture peak at half maximum value). For each texture components (orientation) you can evaluate width of orientation peak using cross-sections of component peak and sliders:

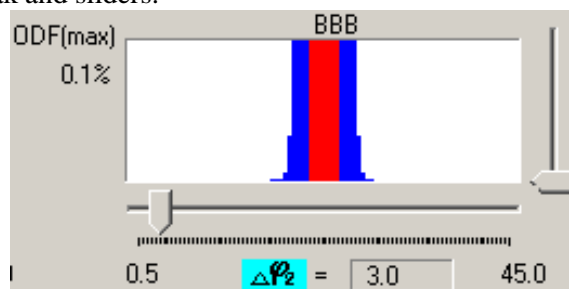

- 1) select component (press component number or click on the component or any sym. equivalent on the list)
- 2) use slider from right side of 3 diagram to finding minimal value (background) of peak
- 3) use slider from right side of 3 diagram to finding maximal value of peak
- 4) evaluate 1/2 high of peak and set this high using slider from right side of 3 diagram
- 5) measure width of peak (on the top of the diagram) for each Euler angle using slider below diagram

5. Volume fraction calculation

Next please click on the button "Calculate Volume Fraction of Texture Components"

Calculate Volume Fraction of Texture Components

and you can see results of calculation of volume fraction:

Φ	$\Delta\Phi$	Volume Fraction [%]
	12.5	58.90 %
	10.0	12.60 %
	12.5	14.31 %
	10.0	%
	10.0	%
	10.0	%
	10.0	%
	10.0	%
	10.0	%
	10.0	%
	10.0	%
	10.0	%
	10.0	%
	10.0	%
	Background	0.00 %
	The Rest	14.19 %
	Orientations Overlap	0.00 %

Full report is available when you click on the "View Report" button:

View Report

 LaboTex - Texture - Quantitative Analysis Report

User: SMITH
 Project: Demo
 Sample: 111-POL
 Job: 1
 Date:2002/12/10
 Time:12:37:51

Overlapping of Symmetrically Equivalent Orientations - Calculation Strategy:

*** Singly Counts in Overlapping Area ***

Calculation Options:

Divide ODF in Overlap Area Among Overlapping Orientations :

*** Off ***

Volume Fraction	Delta Phi1	Delta Phi	Delta Phi2	Orientation
58.90	fiber	5.00	12.50	< 1 1 1 > fiber
12.60	fiber	5.00	10.00	< 1 1 5 > fiber
14.31	fiber	7.50	12.50	< 1 4 5 > fiber

0.00 Background Volume Fraction
 14.19 The Rest Volume Fraction
 0.00 Orientations Overlap Volume Fraction

 Because orientation ranges don't overlap, "Orientations Overlap Volume Fraction" is equal zero.

Orientations Overlap 0.00 %

In this case the choice of calculation both method 1 and 2 give the same results.

The overlapping problem appears when integration ranges (delta) are too wide or when orientations are closely together in Euler angles space. Integration area of texture components can be overlapped in two ways:

i) Overlapping of integration ranges between symmetrically equivalent orientations (positions) of component. Figure below shows overlapping between symmetrically equivalent positions of $\langle 145 \rangle$ fiber components ($\langle 451 \rangle$ fiber and $\langle 541 \rangle$ fiber sym.eq.).

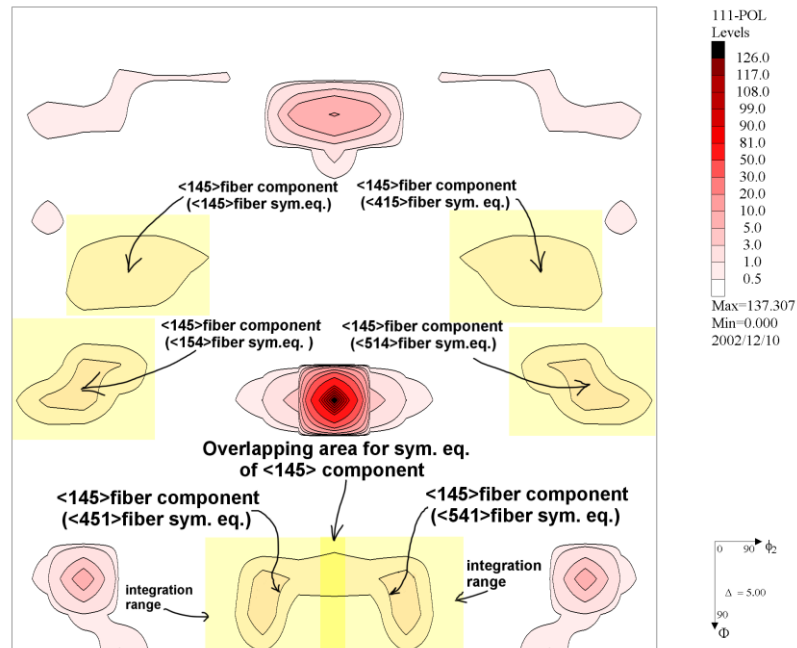

LaboTex gives three different abilities (strategy) to solve problem of overlapping of integration ranges between symmetrically equivalent positions of component (case i) :

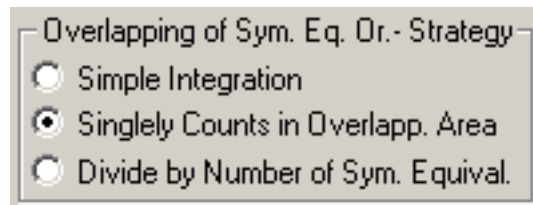

- "Simple Integration" - overlapping region is multiply integrated. Integration around any single component in full range of basic region gives (100% minus background)*number of symmetrically equivalent position.
- "Singlely Counts in Overlapping Area" - overlapping region is only singlely integrated for component. Integration around any single component in full range of basic region give 100% minus background.
- "Divide by Number of Symmetrically Equivalent Position" - LaboTex integrates for all symmetrically equivalent positions of the components with proper weight equal 1/number of symmetrically equivalent positions. Integration around any single components in full range of basic region give 100% minus background.

ii) Overlapping of integration ranges between different components. Figure below shows overlapping of integration ranges between different components: $\langle 111 \rangle$ fiber (green area) and $\langle 145 \rangle$ fiber (yellow areas):

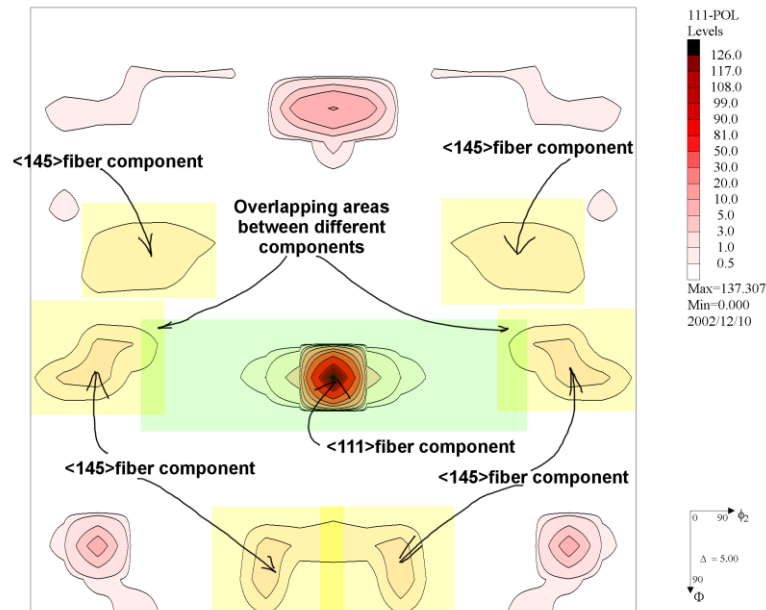

To solve problem of overlapping of integration ranges between different components LaboTex offers (case ii):

- Total percent of overlapping (overlapping volume fraction) is displayed in special window ("Orientations Overlap").



Overlapping volume fraction can be limited by diminishing integration ranges of texture components.

1. In case of "Simple Integration" overlapping volume fraction means sum of overlapping between different components and between symmetrically equivalent positions of all overlapped components.
 2. In case of "Singlely Counts in Overlapping Area" overlapping volume fraction means sum overlapping between different components.
 3. In case of "Divide by Number of Symmetrically Equivalent Position" overlapping volume fraction means excessive orientation overlap. Excessive orientation overlap area is defined in the points where sum of weights is greater than 1. The weight is equal to 1/number of symmetrically equivalent positions. Excessive ODF value in given point is equal to the product of the ODF value and sum of weights minus 1. The volume fraction of excessive orientation overlap is the integral of excessive ODF values in mentioned area.
- Overlapping volume fraction can be divided among overlapping orientations. This option causes the division of ODF values from overlap areas among overlapping orientations:

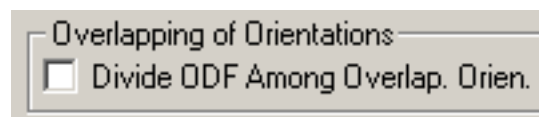

1. in case of "Simple Integration" and "Singlely Counts in Overlapping Area" ODF values in overlapping areas are divided proportionally to number of symmetrically equivalent overlap orientations.
2. in case of "Divide by Number of Symmetrically Equivalent Position" excessive ODF values in overlapping areas are divided among components proportionally to the weights and to number of symmetrically equivalent overlapping orientations.

"Singlely Counts in Overlapping Area" is the most universal method and it is set as default method.